

FN1-039XW220JBW Range

0.39" (10 mm) Single Digit White 7 Segment Display



Features:

- High intensity white LED display
- Black face for maximum contrast
- White diffused segment in off-state
- Ideal for use in applications requiring the display of high definition numeric digits:
 - ❑ Audio equipment
 - ❑ Domestic appliances
 - ❑ Digital clocks

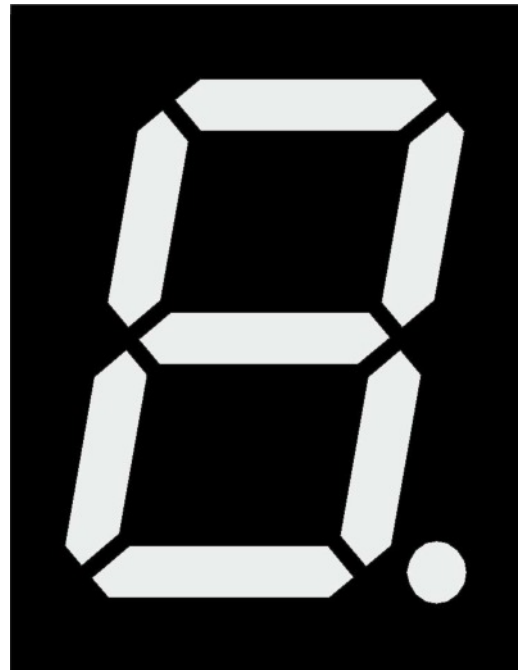

Contents:

- Electro / Optical Characteristics - Page 2
- Maximum Rated Values - Page 2
- Package Outline and Diagrams - Page 3

FN1-039XW220JBW Range

0.39" (10 mm) Single Digit White 7 Segment Display



Electro / Optical Characteristics $I_F = 20\text{mA}$, $T_a = 25^\circ\text{C}$

Part Number		Emitting Colour	Chromaticity Coordinates		Forward Voltage		Luminous Intensity, I_v	
Common Cathode	Common Anode		x	y	Typ	Max	Min	Typ
FN1-0391W220JBW	FN1-0392W220JBW	White	0.30	0.30	3.20	3.70	~	40
Units					V		mcd / seg	

Maximum Rated Values $T_a = 25^\circ\text{C}$ (Derate Above 25°C)

Characteristic	Condition	Symbol	Rating	Units
Pulse Forward Current	0.1 duty cycle @ 1kHz	I_{FP}	100	mA
DC Forward Current		I_F	20	mA
Reverse Voltage	$I_R = 10\mu\text{A}$	V_R	5	V
Operating Temperature		T_{opr}	-25 to +80	$^\circ\text{C}$
Storage Temperature		T_{stg}	-30 to +85	$^\circ\text{C}$
Lead Soldering Temperature	1.6mm from body - max 3 seconds		260	$^\circ\text{C}$

Note

Industry standard procedures regarding static must be observed when handling white LED displays as they are produced using blue die material.

Chromaticity coordinates to CIE 1931 Standard

FN1-039XW220JBW Range

0.39" (10 mm) Single Digit White 7 Segment Display



Package Outline and Diagrams

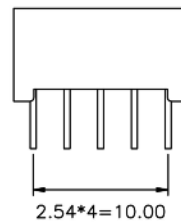
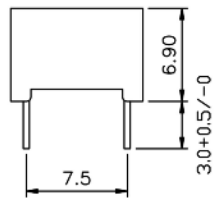
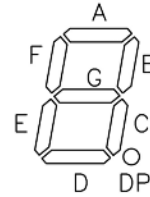
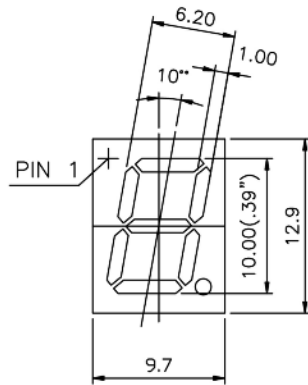

Tolerance ± 0.25 mm unless stated

Common Cathode

Common Anode

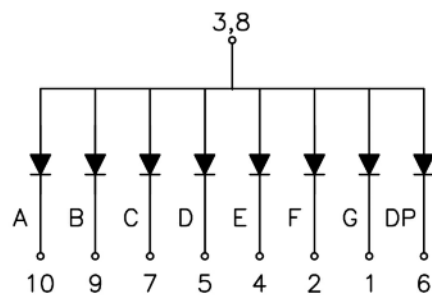
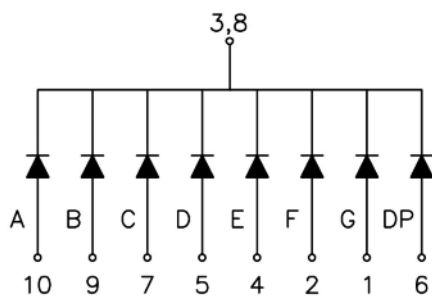

Disclaimer

No representation, warranty, responsibility or liability is or will be accepted by Forge Europa Limited in relation to the accuracy or completeness of any information it provides. It is the responsibility of the customer to verify the suitability of the product for its application. All design work supplied by Forge Europa Limited is to be assumed confidential and is the sole property of Forge Europa Limited. It must not be used, copied or disclosed to any third party without the prior written consent of Forge Europa Limited. All contracts are subject to Forge Europa Limited's General Terms and Conditions of Trading which can be found at www.forge-europa.co.uk. E&OE