

Features:

- High segment intensity
- Wide viewing angle
- Range of colours
- Grey face colour
- White segment colour

Available options:

- Alternative face and segment colour
- Alternative font
- Cropped terminal pins
- Alternative emitting colour
- Low current version

Font design

Product not shown
actual size



Electro / Optical Characteristics - $I_F = 20 \text{ mA}$ (* HE Blue - $I_F = 10 \text{ mA}$) $T_a = 25^\circ \text{ C}$

Part Number Common Cathode	Part Number Common Anode	Emitting Colour	Wavelength Peak λ_p	Forward Voltage V_F		Luminous Intensity I_V	
				typical	max	min	typical
FN4-0365L00GW	FN4-0366L00GW	GaAlAs Red	660	1.85	2.00	-	15
FN4-0365300GW	FN4-0366300GW	HE Red	640	2.05	2.50	-	5
FN4-0365Y05300GW	FN4-0366Y05300GW	Yellow	591	2.05	2.40	-	30
FN4-0365200GW	FN4-0366200GW	Green	568	2.10	2.50	-	9
FN4-0365B0500GW	FN4-0366B0500GW	* HE Blue	465	3.70	4.00	-	6
FN4-0365B0100GW	FN4-0366B0100GW	Blue	428	3.80	4.50	-	4
Units			nm	V		mcd / seg. (digit average)	

Maximum Ratings $T_a = 25^\circ \text{ C}$ (Derate above 25° C)

Characteristic	Condition	Symbol	Rating	Units
Pulse Forward Current	0.1 duty cycle @ 1KHz (HE Blue)	I_{FP}	100 (35)	mA
DC Forward Current	(HE Blue)	I_F	25 (15)	mA
Reverse Voltage	$I_R = 10 \mu\text{A}$	V_R	5	V
Operating Temperature		T_{opr}	- 25 to + 80	$^\circ \text{ C}$
Storage Temperature		T_{stg}	- 30 to + 85	$^\circ \text{ C}$
Lead soldering temperature	1.6 mm from body - max 3 seconds		260	$^\circ \text{ C}$

Note

Industry standard procedures regarding static must be observed when handling product produced with blue die material.



Package Outline

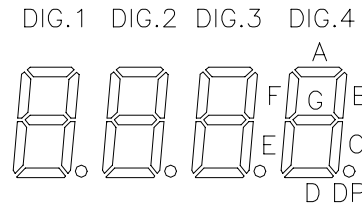
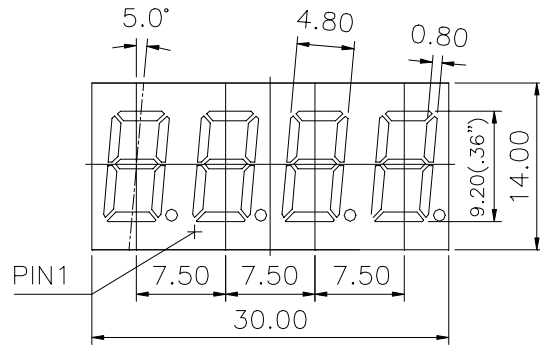

Common Cathode

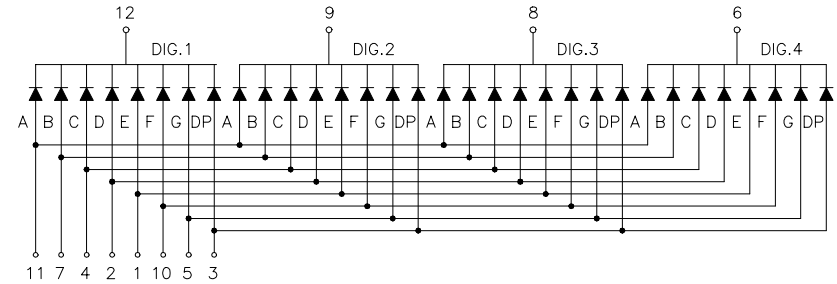

Common Anode

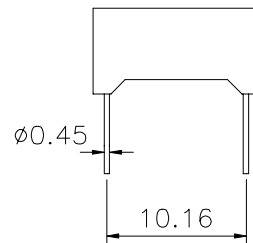
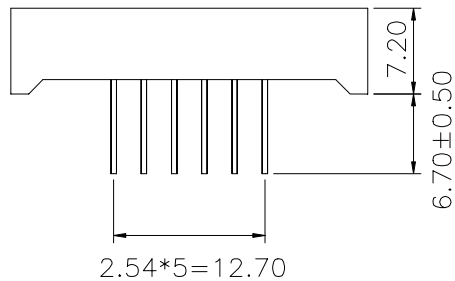
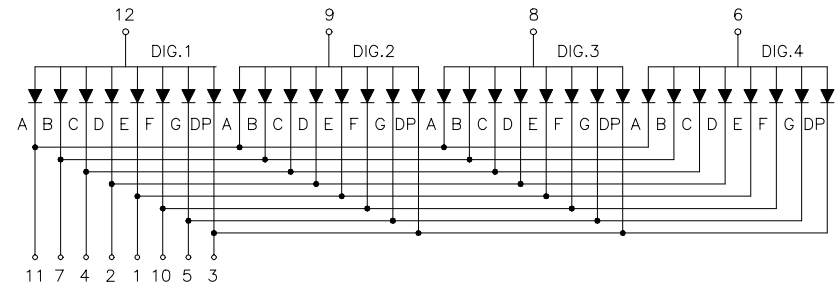

Tolerance ± 0.25 mm unless stated



Forge Limited The Old Railway, Princes Street, Ulverston, Cumbria, LA12 7NQ United Kingdom.
Tel: +44 (0)1229 580000. Email: info@forge-europa.co.uk Website: www.forge-europa.co.uk

No representation, warranty, responsibility or liability is or will be accepted by Forge Europa Limited in relation to the accuracy or completeness of any information it provides. It is the responsibility of the customer to verify the suitability of the product for its application. All design work supplied by Forge Europa Limited is to be assumed confidential and is the sole property of Forge Europa Limited. It must not be used, copied or disclosed to any third party without the prior written consent of Forge Europa Limited. All contracts are subject to Forge Europa Limited's General Terms and Conditions of Trading which can be found at www.forge-europa.co.uk